

Alert and Protect: Illuminate Safety

X-Light Strobe







Designed to deliver powerful visibility and immediate alerts for emergencies. The X-Light Strobe's vibrant, customizable RGBW lighting ensures that crucial notifications are impossible to miss. By incorporating the X-Light Strobe into your safety protocols, you can enhance communication during critical situations, helping to avert potential risks and keeping everyone informed.

How It Works

The X-Light Strobe operates seamlessly within the XSponse ecosystem, utilizing Power over Ethernet (PoE) technology for easy installation and connectivity. When triggered by alarms or specific events, the X-Light Strobe delivers instant visual as well as audible alerts with its integrated buzzer tailored to the nature of the incident, utilizing customizable colors and flash patterns to communicate the urgency of the situation. Its advanced integration with other XSponse devices allows for synchronized alerts across your entire security network, ensuring that all personnel receive the same vital warnings simultaneously. No need to log into multiple devices—once connected to the X-Guardian service, devices automatically deploy in real-time, cutting down installation time. All devices come pre-configured for immediate use upon delivery.



Key Features:

-  Customizable RGBW LEDs: A wide range of colors, flashing patterns, and audible buzzer allow you to tailor alerts to different incidents and convey the urgency of a situation at a glance.
-  Power over Ethernet (PoE): Simplifies installation by providing both power and data through a single Ethernet cable, reducing the need for additional wiring and ensuring a clean setup.
-  Seamless Integration with XSponse Ecosystem: Connects effortlessly with other XSponse devices, allowing for coordinated and synchronized emergency responses that enhance overall situational awareness.
-  Versatile Applications: Ideal for use in schools, places of worship, hospitals, corporate offices, industrial environments, and other industries. The X-Light Strobe adapts to various safety needs, ensuring that alerts are always visible and effective.
-  Easy Configuration and Maintenance: User-friendly setup and management ensure that updates and modifications can be made quickly, keeping your safety protocols up to date without disruption.
-  Epilepsy-friendly strobe: meets safety guidelines to reduce the risk of triggering seizures in individuals with photosensitive epilepsy.

Contact Us
to Learn More!

Toll Free: +1 833-977-6673

www.xsponse.com



Technical Specifications

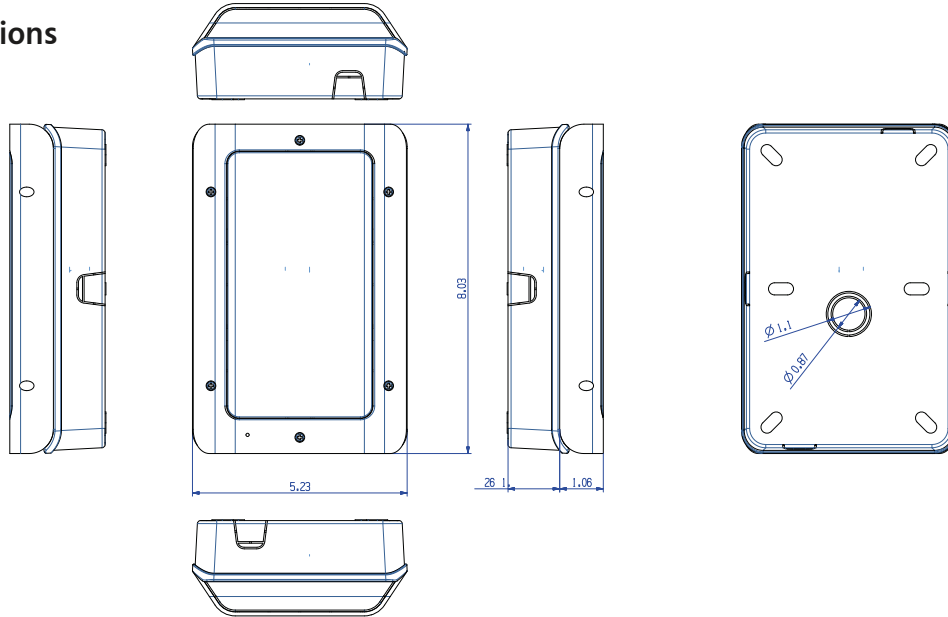

X-Light Strobe	
Product Number	971-0001
Dimensions (L x W x D)	5.23 X 8.03 X 1.70 (inches)
Power Source	PoE+
Processor	ESP32
Max Power	25W
Power Source	PoE
Configuration	Automatic self deployment via X-Guardian platform
Audio	Piezo Buzzer 4.1kHz 90dB at 10cm
Wire Type	Cat5e or greater
Network Protocols	DHCP, HTTP, HTTPS, TCP/IP, ARP, Bonjour, MQTT (Port 8883), UDP, IPv4 / IPv6, mDNS
Network Interface	Ethernet
Mounting	Ceiling/Wall (Includes a back box with wire mold and conduit knock outs)
Status LED	Provides real time status of devices
LED Type	RGB LEDs and cool white LEDs
Vandal Resistance	Yes
Rating	Outdoor rated up to IP67
Warranty	3 Years

All XSpense products utilize an X-Guardian software license connected to an X-Guardian Controller.



**Contact Us
to Learn More!**

Toll Free: +1 833-977-6673

www.xspense.com

